

RMCS

REBAR, MESH &

Construction Supplies (Pty) Ltd t/a RMCS

Tel. +27 (0)11 310 8660 Email. sales@rmcs.com

www.rmcs.com

RATCHET PULLERS



Model 1000 W/H

Model 1500 W/H

Model P-1500-C W/H

Model P-1500-EX-W/H

Model N-1000 W/H

Model N-1500 W/H

Model N-1000P W/H

Model N-1500P W/H

Model N-1500P-EX W/H

Model 4000H

Model N-500

Model P-1500-EXR

Model MINI-PULLER

WIRE GRIPS



Model DV-GRIP

Model MESSEN-L-GRIP-L W/L

Model AL-2TON-GRIP-L W/L

Model AL-MIDDLE-GRIP-L W/L

Model AL-MIDDLE-GRIP-TB W/L

Model AL-MIDDLE-GRIP-LTB W/L

Model AL-LARGE-GRIP-TB W/L

Model TROLLEY-GRIP T4 W/L

Model AL-6TON-GRIP W/L

Model ABC-GRIP-S W/L

Model ABC-GRIP-L W/L

TENSION METERS



Model AS-10L

Model AS-20L

Model D-15

RATCHET WRENCH



Socket 14mm for BS-3

Marking Torque M10

Marking Torque M12

ISO 9001:2000
CERTIFICATED



Accredited by BvA

86-93



REGISTERED FIRM

No. 0 5 5 8

(N.G.K) NAGAKI TOOLS ARE APPROVED AND USED BY UTILITIES IN JAPAN AND ABROAD.

RATCHET-PULLERS

This hook is locked automatically after use. To unlock it, push the plate on the front of the hook with your finger then use normally.

This hook is suitable for all models below.

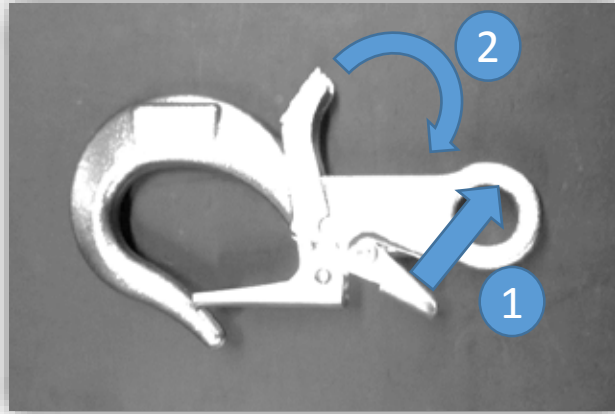

All model using the new safety hooks have the suffix W/H (With safety Hook) in their model names. Please refer to below table.

MODEL	CAPACITY	WIRE/BELT	MIN.L.	MAX.L.	LEVER L.	WT.
1000 W/H	10kN (1.0T)	5.0mm \varnothing	410mm	1210mm	330mm	3.2kg
1500 W/H	15kN (1.5T)	6.3mm \varnothing	450mm	1220mm	430mm	4.4kg
P-1500-C W/H	7.5kN x 15kN	5.0mm \varnothing	460mm	1870/3280mm	430mm	4.2kg
P-1500-EX W/H	7.5kN x 15kN	5.0mm \varnothing	500mm	3500/6500mm	430mm	5.1kg
N-1000 W/H	10kN (1.0T)	2x33mm	420mm	1270mm	400mm	3.3kg
N-1500 W/H	15kN (1.5T)	2x40mm	450mm	1300mm	460mm	4.6kg
N-1000P W/H	10kN (1.0T)	2x33mm	440mm	1940mm	400mm	3.4kg
N-1500P W/H	15kN (1.5T)	2x40mm	470mm	1970mm	460mm	4.7kg
N-1500P-EX W/H	7.5kN x 15kN	2x40mm	500mm	2000/3500mm	460mm	5.1kg

The new development on the 4TON chain puller is the new hook. The model 4000 has two clevis on both sides, the model **4000H** have **two hooks instead**. Workers can now easily attached the chain puller to the pole or the wire grip.

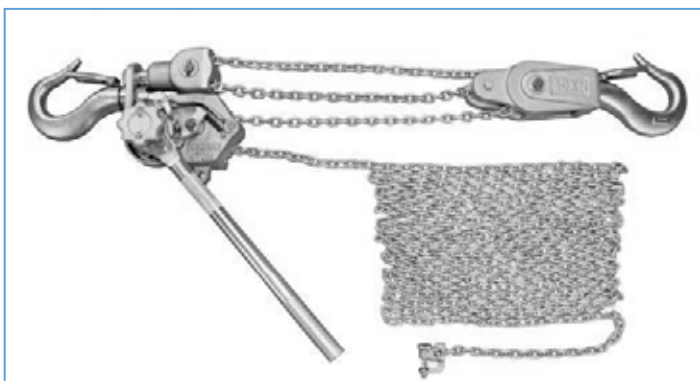

Model 4000H

MODEL	CAPACITY	CHAIN DIA.	MIN.L.	MAX.L.	LEVER L.	WT.
4000H	40kN (4.0T)	5.0mm \varnothing	580mm	2180mm	430mm	15kg

RATCHET-PULLERS

Model N-500

(All web strap can be expected insulating factor when dry and clean)

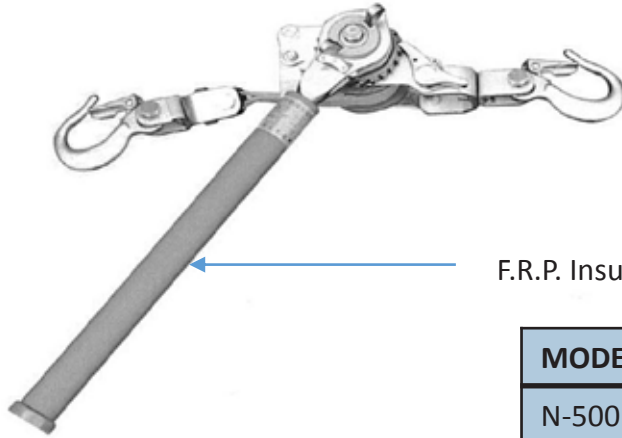

F.R.P. Insulated handle

MODEL	CAPACITY	BELT SIZE	STROKE	WT.
N-500	5kN (0.5T)	2x33mm	800mm	2.8kg

Model P-1500-EXR

The model P-1500-EXR is very similar to the model P-1500-EX. The customer can now **remove the third hook** (red on the previous page) **without removing the wire**. It is a great feature for customers performing **maintenance** on our pullers.

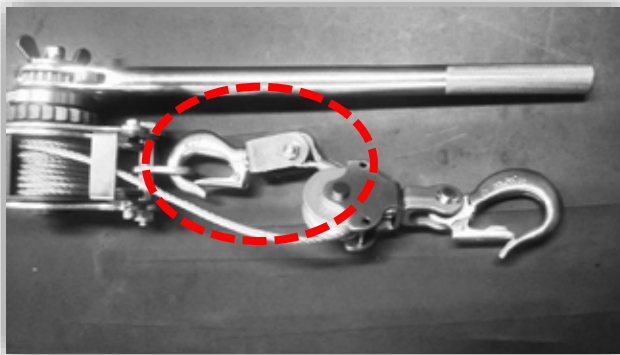

MODEL	CAPACITY	WIRE DIA.	MIN.L.	MAX.L.	LEVER L.	WT.
P-1500-EXR	15kN (1.5T)	5mm Ø	500mm	3500/6500mm	430mm	5.2kg

Model MINI-PULLER

Equipped with:

- Alloy-steel link chain
- Drop Forged & heat treated hooks

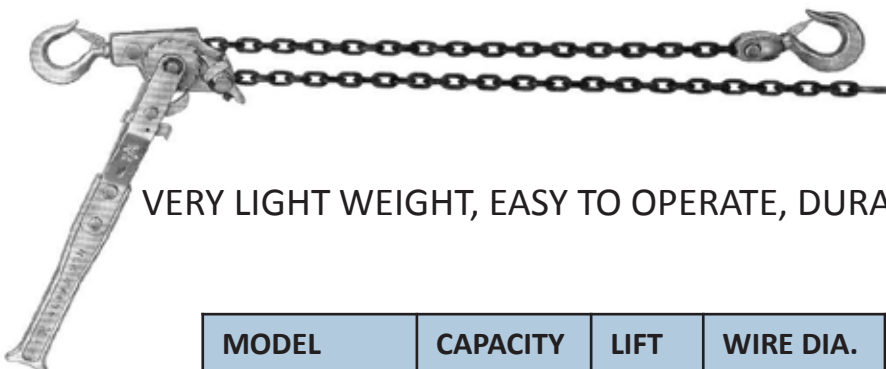

VERY LIGHT WEIGHT, EASY TO OPERATE, DURABLE LIFT, LOWER, PULL, TIGHTEN

MODEL	CAPACITY	LIFT	WIRE DIA.	MIN.L.	LEVER L.	B.S.	WT.
MINI PULLER	7.5kN	1.1m	5.6mm Ø	330mm	400mm	3TON	4.1kg

WIRE GRIPS

We developed a new series of wire grips adding three new features!

The “L” type is our new locking grip. There are three safety feature on this wire grip. The safety latch to prevent the grip to fall of the cable, the locking bolt to **prevent** any short period (a few days) **back tension**, and the locking nut to prevent long term back tension (a few months). The back tension happens when they are vibration on the cable (for example, a power line near a train).

The “TB” type means Thumb and Bend. The trigger allows you to manipulate the wire grip with only **one hand**. The bending on the long lever prevent the cable to twist during pulling.



MESSEN-L-GRIP-L W/L

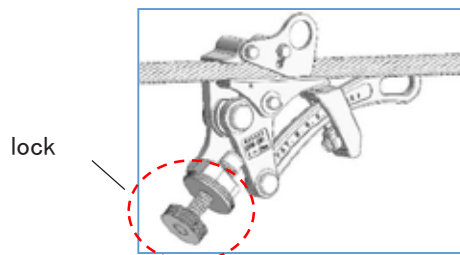

AL-2TON-GRIP-L W/L

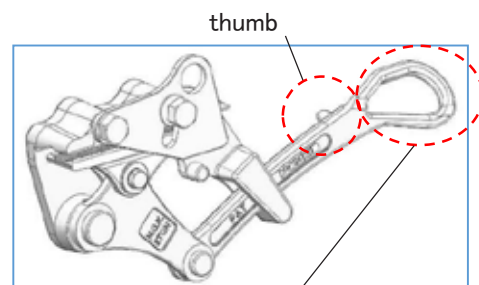

AL-MIDDLE-GRIP-LTB W/L

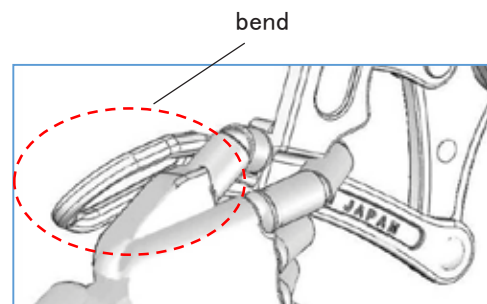

MODEL	Load	MIN CABLE DIA.	MAX CABLE DIA.	JAW SIZE	EYE SIZE	APP. CABLE	Features	WT.
MESSEN-L-GRP-L W/L	1.0T	4mm	12mm	50mm	32mm	CU, Steel, Messen.	Lock	1.2kg
AL-2TON-GRIP-L W/L	2.0T	5mm	16mm	100mm	32mm	AL	Lock	2.0kg
AL-MIDDLE-GRIP-L W/L	2.0T	5mm	25mm	110mm	32mm	AL	Lock	2.3kg
AL-MIDDLE-GRIP-TB W/L	2.0T	5mm	25mm	110mm	32mm	AL	Bend, Trigger	2.0kg
AL-MIDDLE-GRIP-LTB W/L	2.0T	5mm	25mm	110mm	32mm	AL	Lock, Bend, Trigger	2.3kg
AL-LARGE-GRIP-TB W/L	2.0T	16mm	32mm	110mm	32mm	AL	Bend, Trigger	2.2kg

WIRE GRIPS

Model DV-GRIP

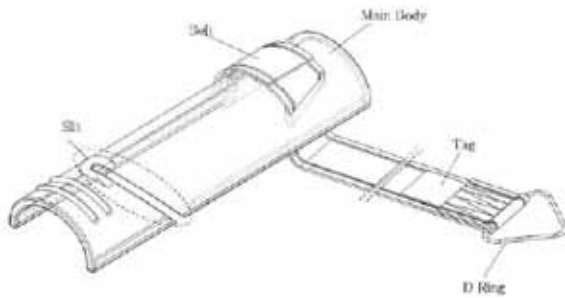

MODEL	Load	Min cable	Max cable
DV-GRIP	3kN	3x38mm ²	3x100mm ²

Model AL-6TON-GRIP W/L

For Bare Aluminum cable and bare copper cable

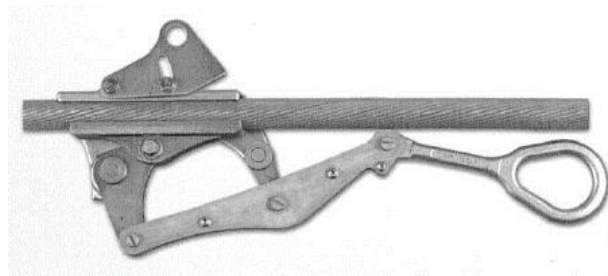

MODEL	Load	Min Dia.	Max Dia.	WT.
AL-6TON-GRIP W/L	6TON	28mm	40mm	8kg

Model TROLLEY-GRIP T4 W/L

For trolley cable, messenger wire, wire rope and copper cable of Railway.

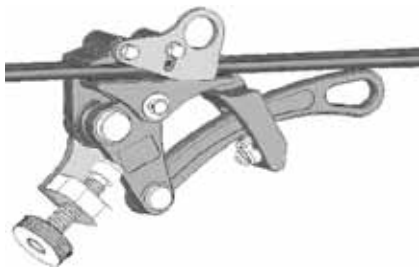

MODEL	Load	Min Dia.	Max Dia.	WT.
TROLLEY-GRIP T4 W/L	4TON	13mm	28mm	5.2kg

Model ABC-GRIP-S W/L Model ABC-GRIP-L W/L

For Aerial Bundled Cable

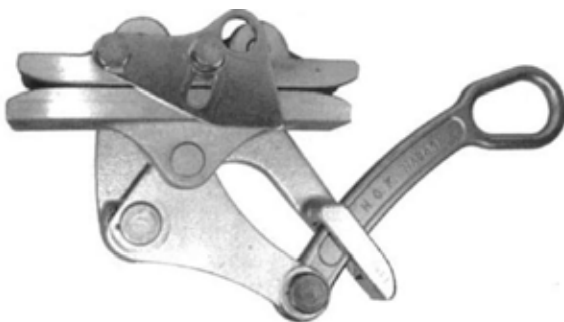

MODEL	Load	Min cable	Max cable
ABC-GRIP-S W/L	6kN	2x16mm ²	4x35mm ²
ABC-GRIP-L W/L	20kN	4x95mm ²	4x150mm ²

TENSION METER

For measurement of tension and load.

The models AS-10L and AS-20L are analogue tension meters **with larger eyes** (larger than the previous models AS-10 and AS-20).

VERY SMALL, VERY LIGHT WEIGHT, VERY COMPACT



AS-10L

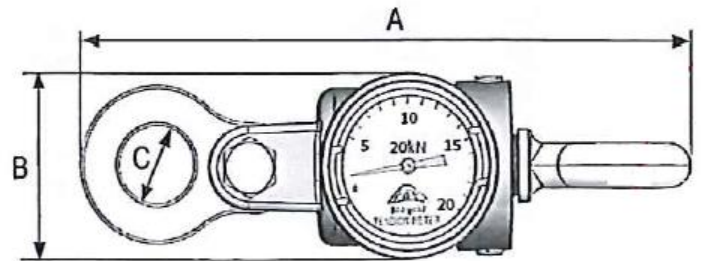

AS-20L ($\pm 3\%$ F.S.)

MODEL	CAPACITY	GRADUATION	A	B	C	WT.
AS-10L	10kN	100N	210mm	65mm	28mm	1.2kg
AS-20L	20kN	200N	230mm	65mm	28mm	1.6kg

For customers who prefers an digital tension meter, we developed the "D" series. Available in 1.5TON and soon 5TON, this new **light and compact digital tension meter** allows the worker to measure the tension applied with precision.



D-15

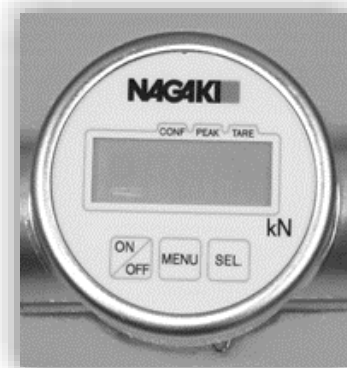

Screen

MODEL	CAPACITY	A	B	C	WT.
D-15	15kN	238mm	85mm	35mm	2kg

WIRE GRIPS

The marking torque is a product that we developed with JR (Japan Railway). JR requested a tool that could mark a bolt when fastening it. We developed a torque wrench, that have an ink inside. When **the torque is reached, the bolt is automatically marked**. It is a great tool to have a visual check (control if everything is under the right tension) on all the bolts and nuts. We developed three models that have different torque and sizes.

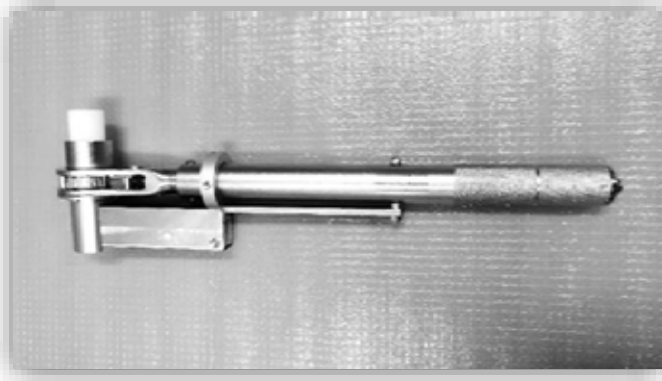

Marking Torque 28

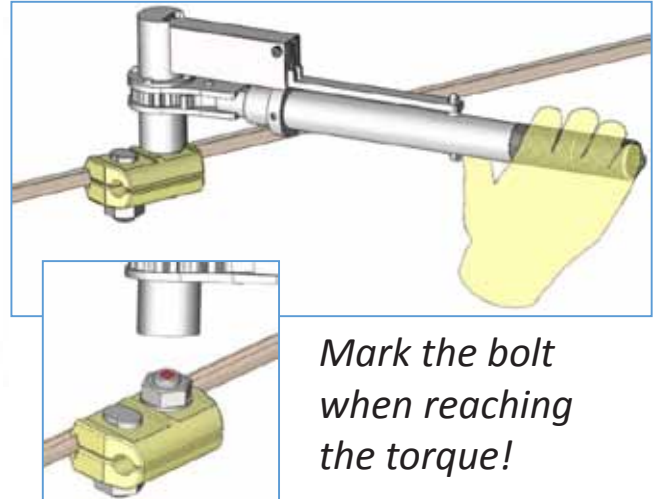

MODEL	SIZE	TORQUE	LENGHT	WT.
Marking Torque 46	M10 (17mm)	46N.m	320mm	0.9kg
Marking Torque 28	M12 (19mm)	28N.m	320mm	0.9kg

The socket 14 is used on our ratchet wrench BS-3. This gives the worker a tool that cover **5 sizes: 14, 17, 19, 22 and 24mm**



Socket 14 for Model BS-3

MODEL	SIZE	WT.
Socket 14	14mm	110g

- Please be sure to read the attached instruction manual prior to use.
- Please note that in case of any improvements made in the products, the above specifications may change without prior notice.

MANUFACTURED BY NAGAKI (N.G.K)
ISO 9001:2000 CERTIFICATED

DISTRIBUTED BY RMCS

RMCS

REBAR, MESH &
Construction Supplies (Pty) Ltd t/a RMCS

571 Setter Road, Commercia Industrial
Midrand, Gauteng Province, 1685

Tel. +27 (0) 11 310 8660 Fax. +27 (0) 86 545 6012
Email. sales@rmcs.com Web. www.rmcs.com